

Article number: 432000085

Description: Rota-fix shaft-hub connection A 85x125
Steel

Note: Not self centering. Medium-high torques.

Measures

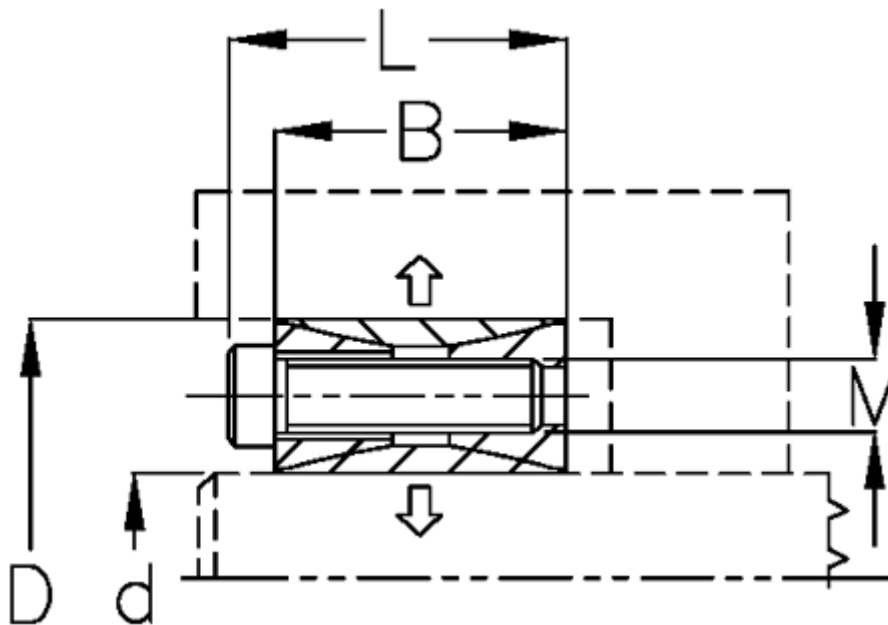

B mm	= 28
d H8 mm	= 85125
D mm	= 125
Fit tolerance	= Aksel k11-h11, Nav N11-H11
F kN torque	= 159.0
L mm	= 38
M mm	= M10
P N/mm ² surface pressure on shaft/hub	= 140

Surface roughness	=
T N m torque	=
Ts N m bolt tightening torque	=